



door hardware online  
authorized distributors of the  
**Briton** brand

**Briton**

Panic and  
emergency exit  
hardware

376 Series Spares

**Life Safety - The Importance of Meeting The Standards**

In the event of a fire or other emergency your safety, and indeed your life, depends upon the reliability of the exit devices. You need to know that they will open first time, every time. The new European standards have been developed to provide you with a means of ensuring that you are buying and installing products that you can be sure will operate correctly when they are required.

Briton are committed to not only attaining, but exceeding all the latest standards because they value the lives of everyone who may depend on their products.

**What Are The New Standards?**

BS EN 1125: 2008 applies to panic exit hardware, for use in any building that may be used by the public or someone without prior knowledge of the device. BS EN 179: 2008 applies to emergency exit hardware and should only be used in circumstances where you are sure that the building is not used by people who are unfamiliar with it.

**The Importance of Regular Maintenance**

Recommendations laid down under the new standards suggest that the following routine maintenance checks should be undertaken at intervals of not more than one month:

- Inspect and operate the panic device to ensure that all components are in a satisfactory working condition
- Ensure that the keeper(s) is (are) free from obstruction. In heavy use areas these items can suffer abuse and become damaged.

In these circumstances it is imperative that the exit devices are regularly checked to ensure they are kept in good working order and will function effectively when they are needed. To assist you in keeping these products fully operational we have devised this comprehensive Spares Manual to provide you with a detailed list of the individual items that can be purchased.

**How to Use This Spares Manual**

Each item has a unique identification number. They have been classified into spare parts, accessories and screws packs.

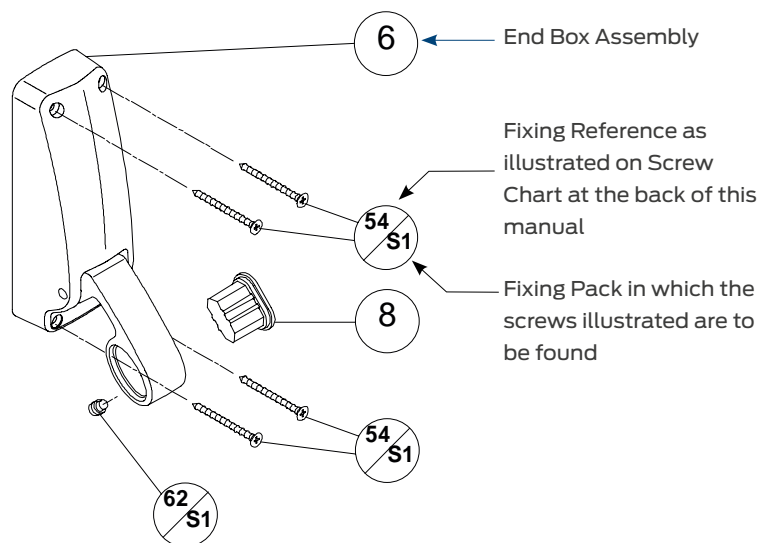

**Example:**  
 If you need a replacement end box for a Briton 376 Vertical Panic Bolt

1. Firstly select the exploded drawing of the 376 and identify the part required
2. Identify the items number for the end box (item 6) and appropriate fixing pack (S1)
3. Look up item number in table for product code (item 6 is 376/1011/\*\*)
4. \*\* denotes you must specify the finish required (e.g 376/1011/SE is powder coated silver
5. Check recommendations column for screw pack details and associated items that we advise you purchase with this part
6. You can purchase these items from any Ingersoll Rand stockist. For your nearest supplier contact our Customer Care Centre on 08706 012012
7. Need further help? For technical advice call our Technical Services on 0800 834102

# Vertical Bolts to BS EN 1125 - Briton 376; 376.D; 376.A

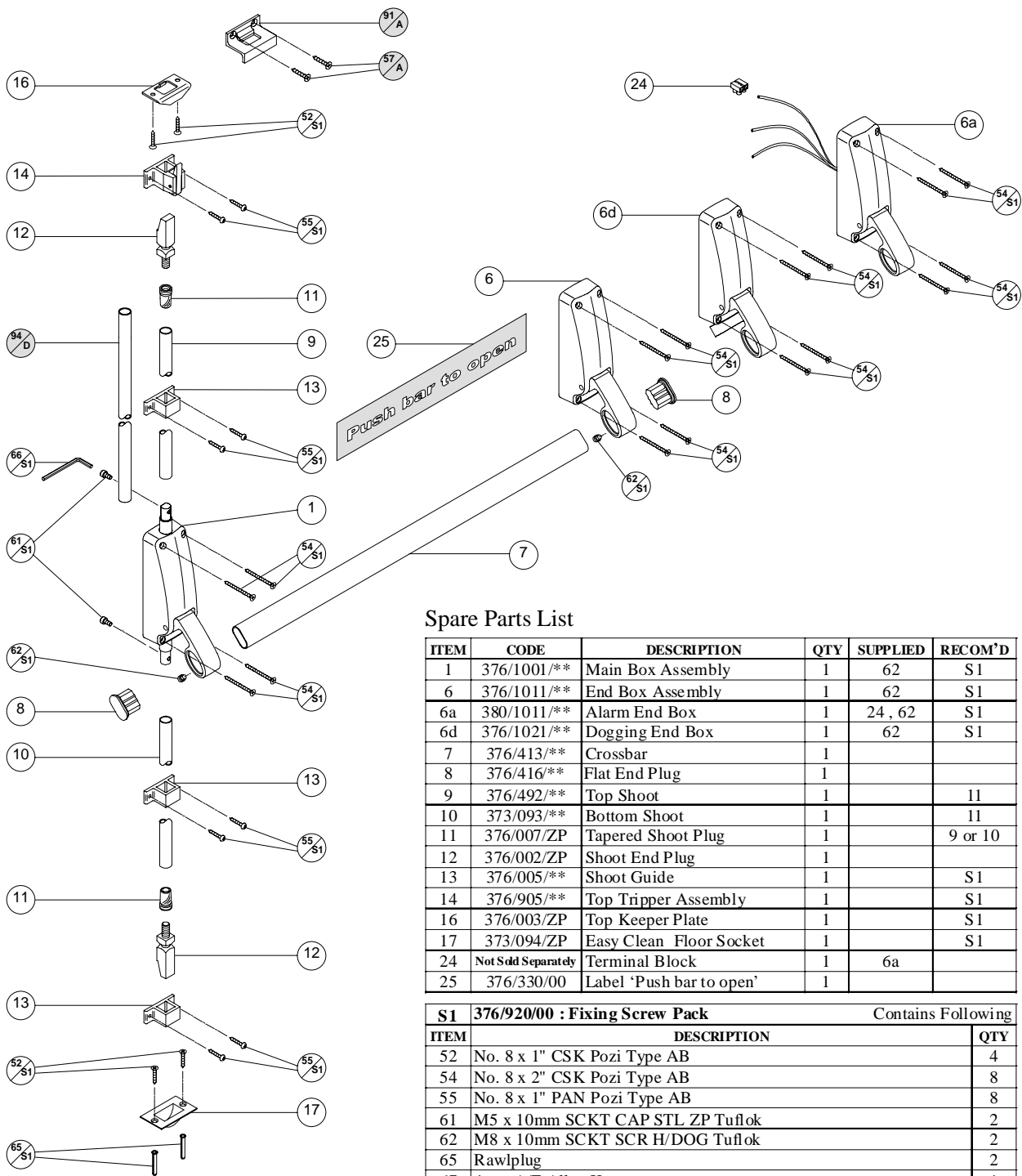

### Spare Parts List

ITEM	CODE	DESCRIPTION	QTY	SUPPLIED	RECOM'D
1	376/1001/**	Main Box Assembly	1	62	S1
6	376/1011/**	End Box Assembly	1	62	S1
6a	380/1011/**	Alarm End Box	1	24 , 62	S1
6d	376/1021/**	Dogging End Box	1	62	S1
7	376/413/**	Crossbar	1		
8	376/416/**	Flat End Plug	1		
9	376/492/**	Top Shoot	1		11
10	373/093/**	Bottom Shoot	1		11
11	376/007/ZP	Tapered Shoot Plug	1		9 or 10
12	376/002/ZP	Shoot End Plug	1		
13	376/005/**	Shoot Guide	1		S1
14	376/905/**	Top Tripper Assembly	1		S1
16	376/003/ZP	Top Keeper Plate	1		S1
17	373/094/ZP	Easy Clean Floor Socket	1		S1
24	Not Sold Separately	Terminal Block	1	6a	
25	376/330/00	Label 'Push bar to open'	1		

<b>S1 376/920/00 : Fixing Screw Pack</b>		Contains Following	
ITEM	DESCRIPTION	QTY	
52	No. 8 x 1" CSK Pozi Type AB	4	
54	No. 8 x 2" CSK Pozi Type AB	8	
55	No. 8 x 1" PAN Pozi Type AB	8	
61	M5 x 10mm SCKT CAP STL ZP Tuflok	2	
62	M8 x 10mm SCKT SCR H/DOG Tuflok	2	
65	Rawlplug	2	
67	4mm A/F Allen Key	1	

### Accessories List

<b>A 376FFKP/** : Flush Face Keeper Plate</b>		Contains Following	
ITEM	DESCRIPTION	QTY	SUPPLIED RECOM'D
91	Flush Face Keeper Plate	1	
57	No. 10 x 1" CSK Pozi Type AB	2	

<b>D 376ELTS/** : Extra Long Top Shoot</b>		Contains Following	
ITEM	DESCRIPTION	QTY	SUPPLIED RECOM'D
94	Extra Long Top Shoot	1	11

# Vertical Bolts to BS EN 1125 With Pullman Latches - Briton 376.P; 376.PD; 376.PA

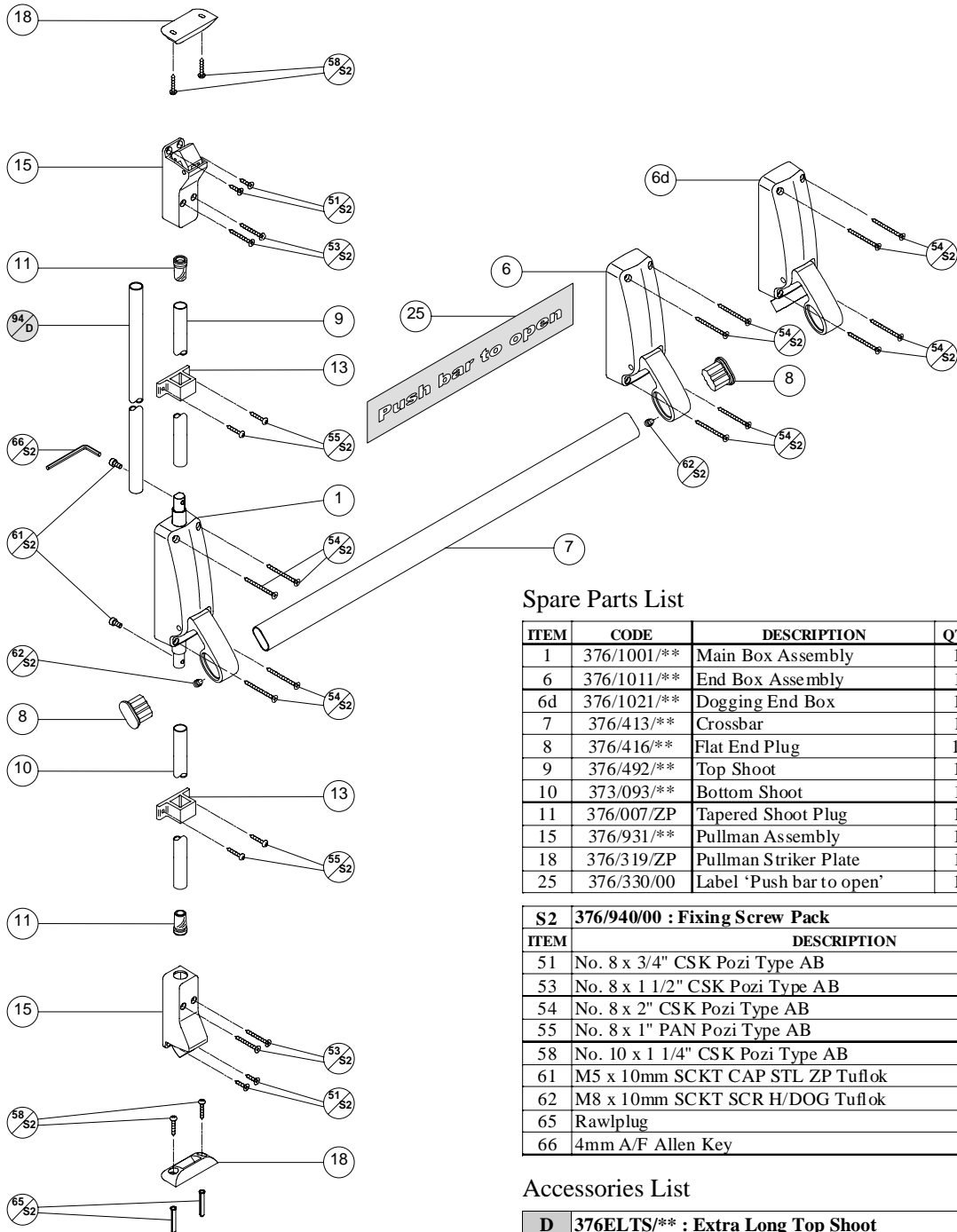

### Spare Parts List

ITEM	CODE	DESCRIPTION	QTY	SUPPLIED	RECOM'D
1	376/1001/**	Main Box Assembly	1	62	S2
6	376/1011/**	End Box Assembly	1	62	S2
6d	376/1021/**	Dogging End Box	1	62	S2
7	376/413/**	Crossbar	1		
8	376/416/**	Flat End Plug	1		
9	376/492/**	Top Shoot	1		
10	373/093/**	Bottom Shoot	1		11
11	376/007/ZP	Tapered Shoot Plug	1		11
15	376/931/**	Pullman Assembly	1		9 or 10
18	376/319/ZP	Pullman Striker Plate	1	S2	
25	376/330/00	Label 'Push bar to open'	1	S2	

<b>S2 376/940/00 : Fixing Screw Pack</b>		Contains Following	
ITEM	DESCRIPTION	QTY	
51	No. 8 x 3/4" CSK Pozi Type AB	4	
53	No. 8 x 1 1/2" CSK Pozi Type AB	4	
54	No. 8 x 2" CSK Pozi Type AB	8	
55	No. 8 x 1" PAN Pozi Type AB	4	
58	No. 10 x 1 1/4" CSK Pozi Type AB	4	
61	M5 x 10mm SCKT CAP STL ZP Tuflok	2	
62	M8 x 10mm SCKT SCR H/DOG Tuflok	2	
65	Rawlplug	2	
66	4mm A/F Allen Key	1	

### Accessories List

<b>D 376ELTS/** : Extra Long Top Shoot</b>		Contains Following	
ITEM	DESCRIPTION	QTY	RECOM'D
94	Extra Long Top Shoot	1	11

Panic Latch to BS EN 1125 - Briton 378; 378.D

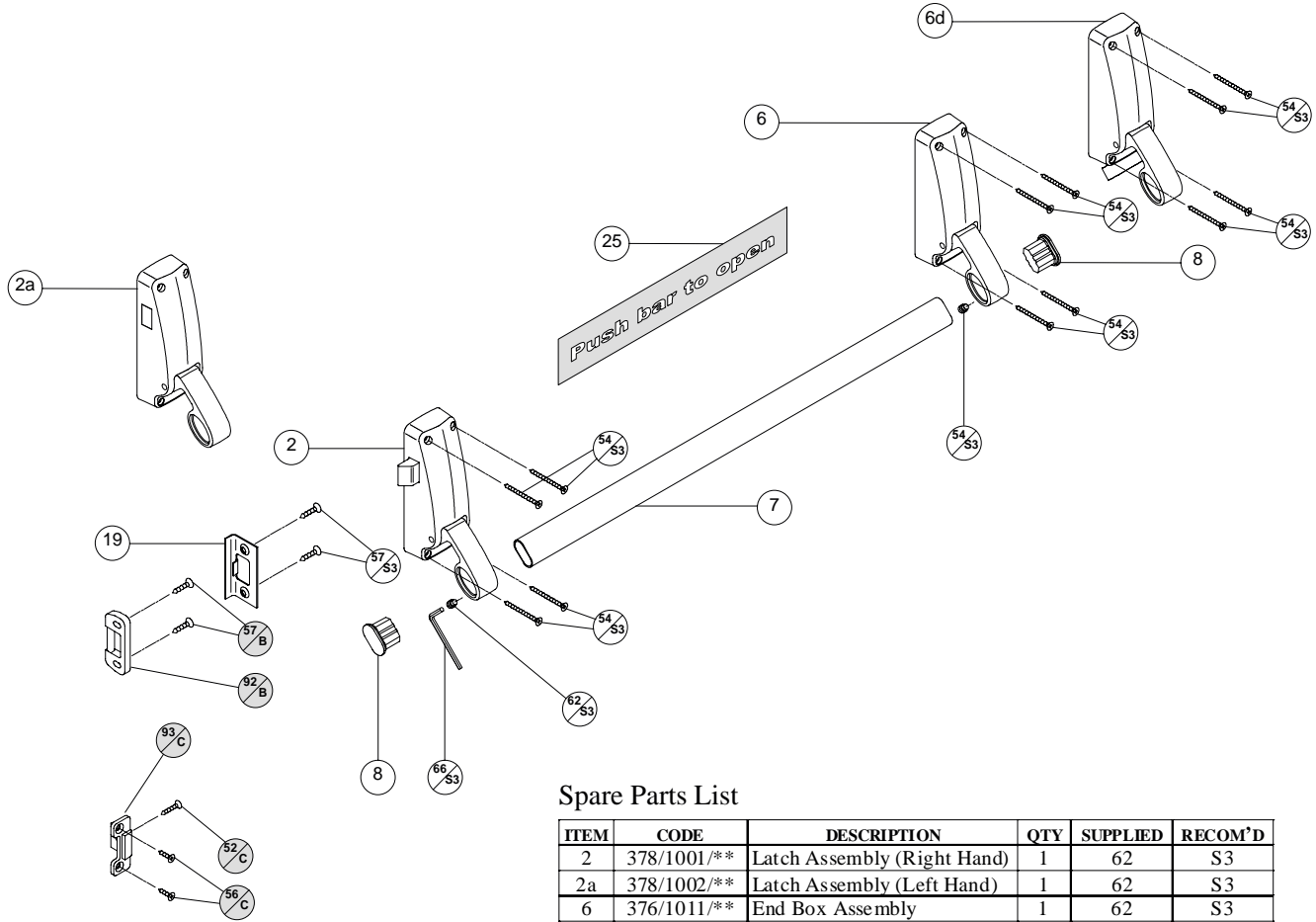

Spare Parts List

ITEM	CODE	DESCRIPTION	QTY	SUPPLIED	RECOM'D
2	378/1001/**	Latch Assembly (Right Hand)	1	62	S3
2a	378/1002/**	Latch Assembly (Left Hand)	1	62	S3
6	376/1011/**	End Box Assembly	1	62	S3
6d	376/1021/**	Dogging End Box	1	62	S3
7	376/413/**	Crossbar	1		
8	376/416/**	Flat End Plug	1		
19	378/316/**	Latch Bolt Keeper Plate	1		S3
25	376/330/00	Label 'Push bar to open'	1		

S3 378/920/00 : Fixing Screw Pack		Contains Following	
ITEM	DESCRIPTION	QTY	
54	No. 8 x 2" CSK Pozi Type AB	8	
57	No. 10 x 1" CSK Pozi Type AB	2	
62	M8 x 10mm SCKT SCR H/DOG Tuflok	2	
66	4mm A/F Allen Key	1	

Accessories List

B 378MDS/** : Metal Door Strike		Contains Following		
ITEM	DESCRIPTION	QTY	SUPPLIED	RECOM'D
92	Latch Bolt Keeper Plate (Metal Door)	1		
57	No. 10 x 1" CSK Pozi Type AB	2		

C 378DDS/** : Double Door Strike		Contains Following		
ITEM	DESCRIPTION	QTY	SUPPLIED	RECOM'D
93	Latch Bolt Keeper Plate (Double Door)	1		
52	No. 8 x 1" CSK Pozi Type AB	1		
56	No. 10 x 3/4" CSK Pozi Type AB	2		

Panic Nightlatch to BS EN 1125 - Briton 379.N; 379.ND; 379.NA

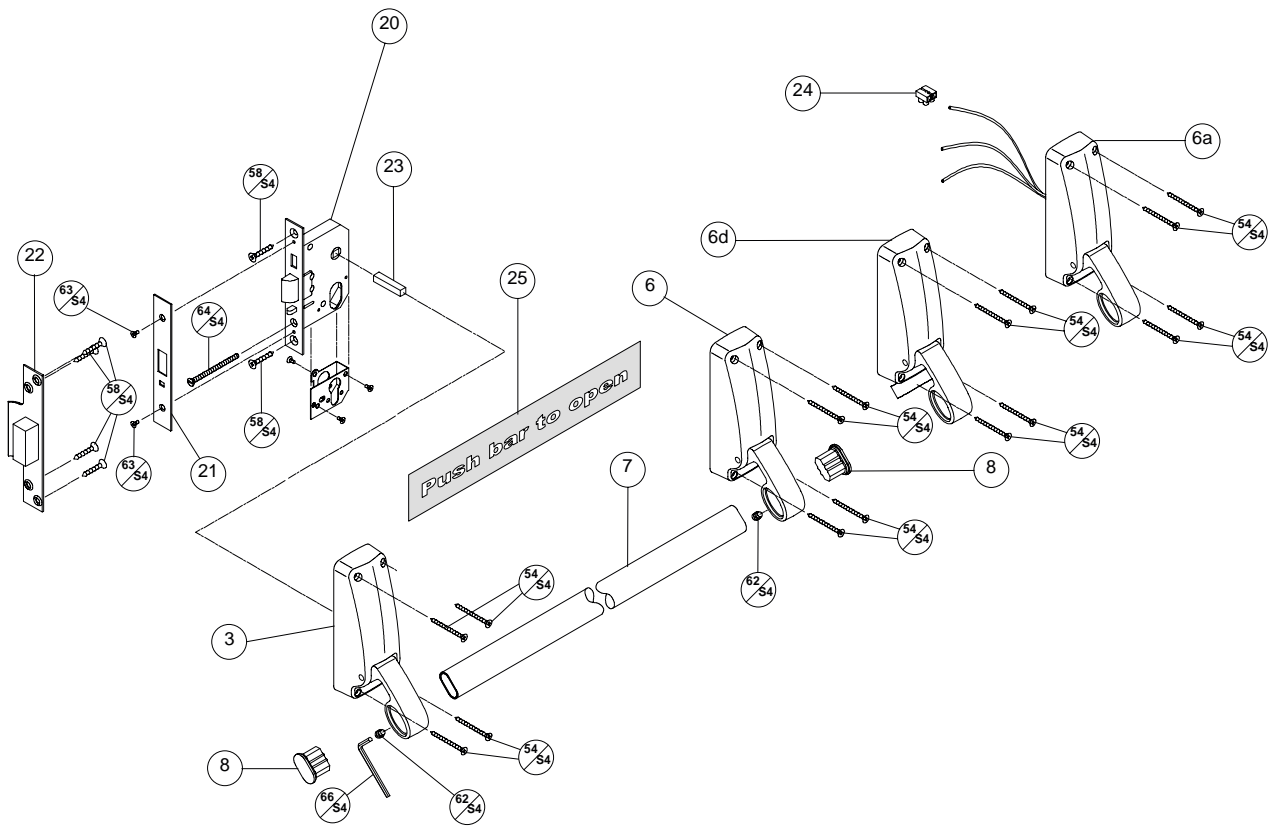

Spare Parts List

ITEM	CODE	DESCRIPTION	QTY	SUPPLIED	RECOM'D
3	379/1001/**	Mortice Latch Assembly	1	23 , 62	S4
6	376/1011/**	End Box Assembly	1	62	S4
6a	380/1011/**	Alarm End Box	1	24 , 62	S4
6d	376/1021/**	Dogging End Box	1	62	S4
7	376/413/**	Crossbar	1		
8	376/416/**	Flat End Plug	1		
20	379/931/SS	Nightlatch Lock Case	1		S4
21	379/341/SS	Outer Forend	1		S4
22	379/932/**	Box Striker Plate	1		S4
23	Not Sold Separately	Mortice Bolt Spindle	1	3	
24	Not Sold Separately	Terminal Block	1	6a	
25	376/330/00	Label 'Push bar to open'	1		

S4 379/940/00 : Fixing Screw Pack		Contains Following	
ITEM	DESCRIPTION	QTY	
54	No. 8 x 2" CSK Pozzi Type AB	8	
60	No. 10 x 1 1/4" CSK Pozzi Type AB	6	
61	M8 x 10mm SCKT SCR H/DOG Tufflok	2	
63	M3.5 x 8mm CSK POZI Taptie ZP	2	
64	M5 x 70mm CSK SLT TL NP	1	
66	4mm A/F Allen Key	1	

# Vertical Bolts to BS EN 179 Briton 372; 1438 Emergency Push Pad Devices

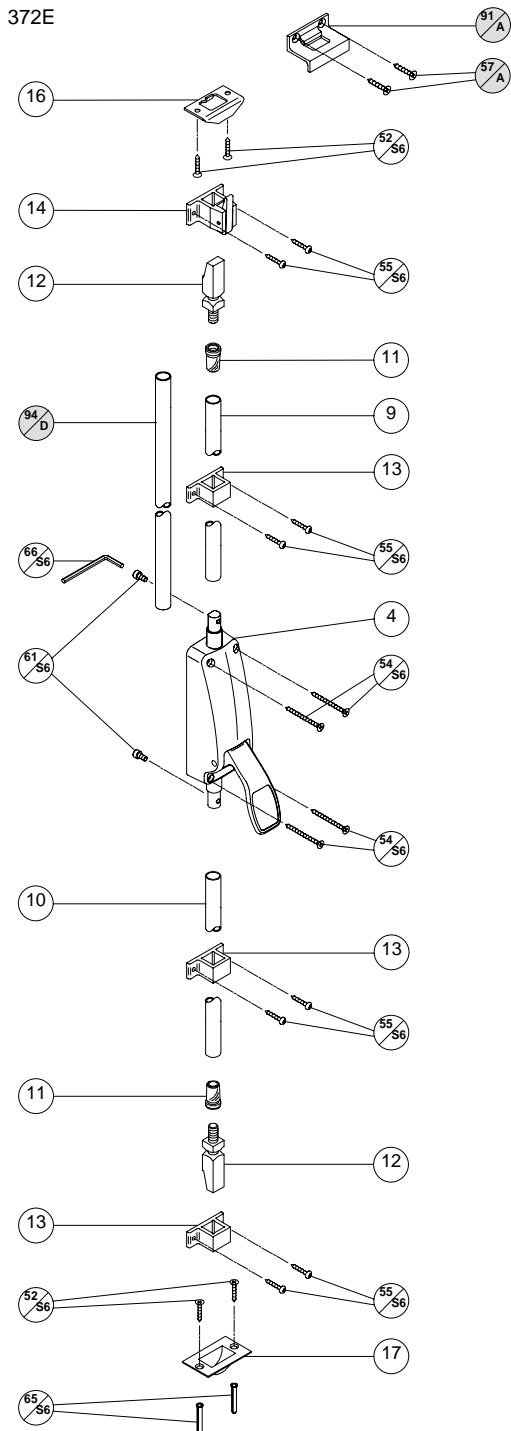

### 372E Spare Parts List

ITEM	CODE	DESCRIPTION	QTY	SUPPLIED	RECOM'D
4	372/1001/**	Push Pad Main Box Assembly	1		S5
9	376/492/**	Top Shoot	1		11
10	373/093/**	Bottom Shoot	1		11
11	376/007/**	Tapered Shoot Plug	1		9 or 10
12	376/002/ZP	Shoot End Plug	1		
13	376/005/**	Shoot Guide	1		S5
14	376/905/**	Top Tripper Assembly	1		S5
16	376/003/ZP	Top Keeper Plate	1		S5
17	373/094/ZP	Easy Clean Socket	1		S5

S5 372/920/00 : Fixing Screw Pack		Contains Following	
ITEM	DESCRIPTION	QTY	
52	No. 8 x 1" CSK Pozi Type AB	4	
54	No. 8 x 2" CSK Pozi Type AB	4	
55	No. 8 x 1" PAN Pozi Type AB	8	
61	M5 x 10mm SCKT CAP STL ZP Tuflok	2	
65	Rawplug	2	
66	4mm A/F Allen Key	1	

### 372E Accessories List







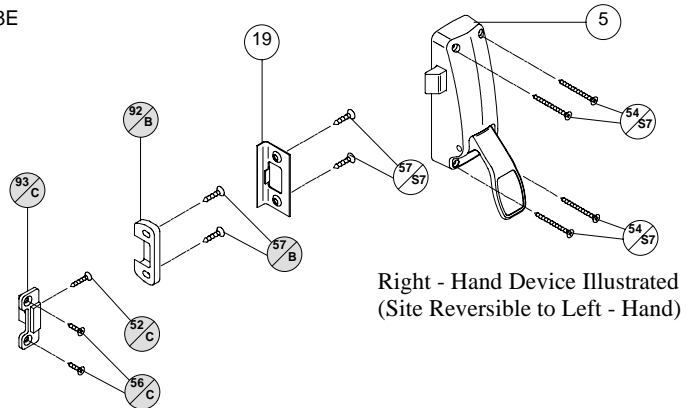















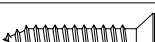

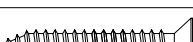

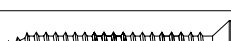

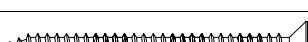

A 376FFKP/** : Flush Face Keeper Plate		Contains Following		
ITEM	DESCRIPTION	QTY	SUPPLIED	RECOM'D
91	Flush Face Keeper Plate	1		
57	No. 10 x 1" CSK Pozi Type AB	2		

D 376ELTS/** : Extra Long Top Shoot		Contains Following		
ITEM	DESCRIPTION	QTY	SUPPLIED	RECOM'D
94	Extra Long Top Shoot	1		11

### 1438E

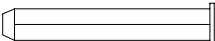

## Exit Hardware - Screw Chart

51	No. 8 x 3/4" LG CSK POZI TYPE AB		
52	No. 8 x 1" LG CSK POZI TYPE AB		
53	No. 8 x 1 1/2" LG CSK POZI TYPE AB		
54	No. 8 x 2" LG CSK POZI TYPE AB		
55	No. 8 x 1" LG PAN POZI TYPE AB		
56	No. 10 x 3/4" LG CSK POZI TYPE AB		
57	No. 10 x 1" LG CSK POZI TYPE AB		
58	No. 10 x 1 1/4" LG CSK POZI TYPE AB		
59	No. 10 x 1 1/2" LG CSK POZI TYPE AB		
60	No. 10 x 2" LG CSK POZI TYPE AB		
61	M5 x 10mm SCKT CAP STL ZP TUFLOK		
62	M8 x 10mm SCKT SCR H/DOG TUFLOK		
63	M3.5 x 8mm CSK POZI TAPTIE ZP		
64	M5 x 70mm CSK SLT STL NP		
65	RAWLPLUG		
66	4mm A/F ALLEN KEY	